



浩畅半导体
www.szhaochang.cn

AO3416 N-Channel Enhancement Mode Power MOSFET

SOT-23 Plastic-Encapsulate MOSFETS

产
品
规
格
书

承
认
书

客户确认：

公司签章：

部门

工程部

品保部

采购部

签名

日期



SOT-23 Plastic-Encapsulate MOSFETS

AO3416 N-Channel Enhancement Mode Power MOSFET

Description

The AO3416 uses advanced trench technology to provide excellent $R_{DS(ON)}$, low gate charge and operation with gate voltages as low as 1.8V. This device is suitable for use as a load switch or in PWM applications. It is ESD protected.

General Features

- $V_{DS} = 20V, I_D = 6.5A$
- $R_{DS(ON)} < 33m\Omega @ V_{GS}=2.5V$
- $R_{DS(ON)} < 27m\Omega @ V_{GS}=4.5V$
- ESD Rating: 2000V HBM
- High Power and current handing capability
- Lead free product is acquired
- Surface mount package

Application

- PWM application
- Load switch

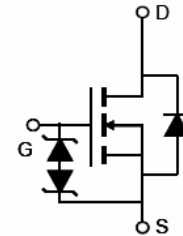

Schematic diagram

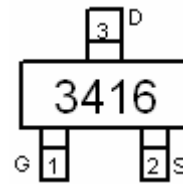

Marking and pin assignment



SOT-23 top view

Package Marking and Ordering Information

Device Marking	Device	Device Package	Reel Size	Tape width	Quantity
3416	AO3416	SOT-23	Ø180mm	8mm	3000 units

Absolute Maximum Ratings ($T_A=25^\circ C$ unless otherwise noted)

Parameter	Symbol	Limit	Unit
Drain-Source Voltage	V_{DS}	20	V
Gate-Source Voltage	V_{GS}	± 12	V
Drain Current-Continuous	I_D	6.5	A
Drain Current-Pulsed ^(Note 1)	I_{DM}	30	A
Maximum Power Dissipation	P_D	1.4	W
Operating Junction and Storage Temperature Range	T_J, T_{STG}	-55 To 150	$^\circ C$

Thermal Characteristic

Thermal Resistance, Junction-to-Ambient ^(Note 2)	$R_{\theta JA}$	89.3	$^\circ C/W$
---	-----------------	------	--------------

Electrical Characteristics ($T_A=25^\circ C$ unless otherwise noted)

Parameter	Symbol	Condition	Min	Typ	Max	Unit
Off Characteristics						
Drain-Source Breakdown Voltage	BV_{DSS}	$V_{GS}=0V, I_D=250\mu A$	20		-	V
Zero Gate Voltage Drain Current	I_{DSS}	$V_{DS}=20V, V_{GS}=0V$	-	-	1	μA

AO3416

Gate-Body Leakage Current	I_{GSS}	$V_{GS}=\pm 10V, V_{DS}=0V$	-	-	± 10	μA
On Characteristics ^(Note 3)						
Gate Threshold Voltage	$V_{GS(th)}$	$V_{DS}=V_{GS}, I_D=250\mu A$	0.45	0.7	1.0	V
Drain-Source On-State Resistance	$R_{DS(ON)}$	$V_{GS}=4.5V, I_D=6A$	-	21	27	$m\Omega$
		$V_{GS}=2.5V, I_D=5A$	-	26	33	$m\Omega$
Forward Transconductance	g_{FS}	$V_{DS}=5V, I_D=4.5A$	8	-	-	S
Dynamic Characteristics ^(Note 4)						
Input Capacitance	C_{ISS}	$V_{DS}=10V, V_{GS}=0V,$ $F=1.0MHz$	-	660	-	PF
Output Capacitance	C_{OSS}		-	160	-	PF
Reverse Transfer Capacitance	C_{RSS}		-	87	-	PF
Switching Characteristics ^(Note 4)						
Turn-on Delay Time	$t_{d(on)}$	$V_{DD}=10V, R_L=1.5\Omega$ $V_{GS}=5V, R_{GEN}=3\Omega$	-	0.5		nS
Turn-on Rise Time	t_r		-	1		nS
Turn-Off Delay Time	$t_{d(off)}$		-	12		nS
Turn-Off Fall Time	t_f		-	4		nS
Total Gate Charge	Q_g	$V_{DS}=10V, I_D=6A,$ $V_{GS}=4.5V$	-	8		nC
Gate-Source Charge	Q_{gs}		-	2.5	-	nC
Gate-Drain Charge	Q_{gd}		-	3	-	nC
Drain-Source Diode Characteristics						
Diode Forward Voltage ^(Note 3)	V_{SD}	$V_{GS}=0V, I_S=6.5A$	-	-	1.2	V
Diode Forward Current ^(Note 2)	I_S		-	-	6.5	A

Notes:

1. Repetitive Rating: Pulse width limited by maximum junction temperature.
2. Surface Mounted on FR4 Board, $t \leq 10$ sec.
3. Pulse Test: Pulse Width $\leq 300\mu s$, Duty Cycle $\leq 2\%$.
4. Guaranteed by design, not subject to production

Typical Electrical and Thermal Characteristics

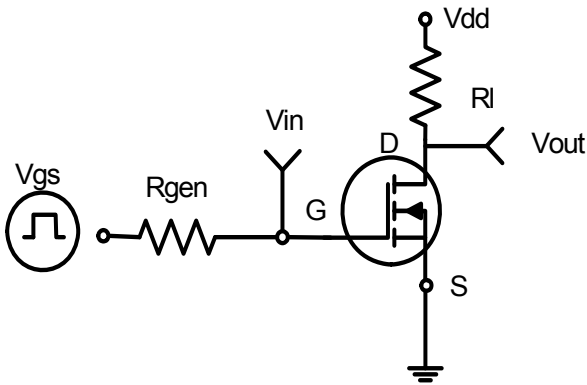

Figure 1: Switching Test Circuit

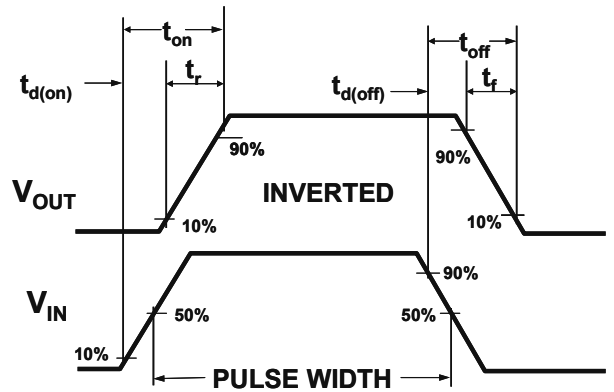

Figure 2: Switching Waveforms

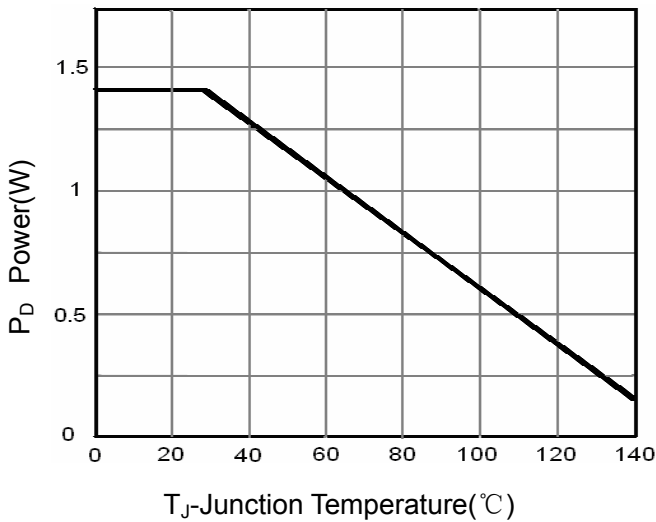

Figure 3 Power Dissipation

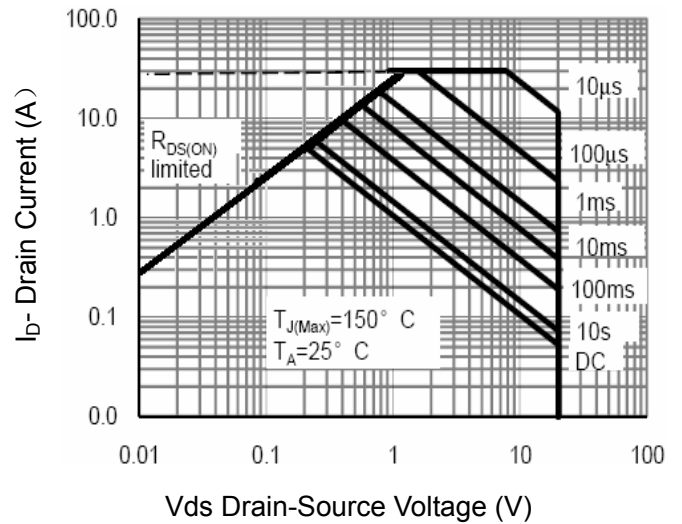

Figure 4 Safe Operation Area

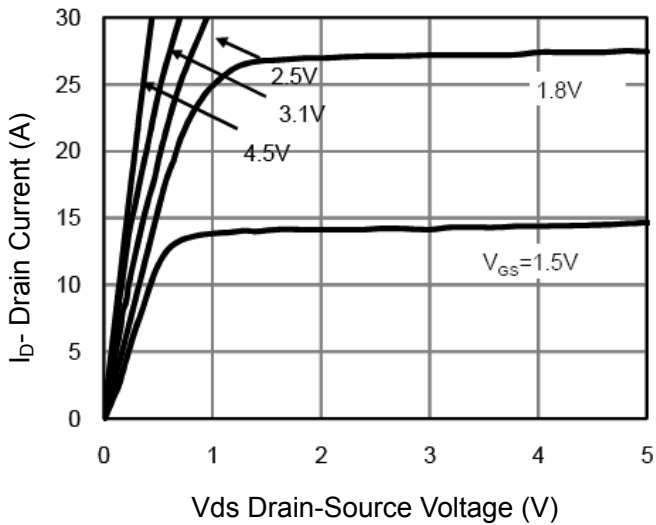

Figure 5 Output Characteristics

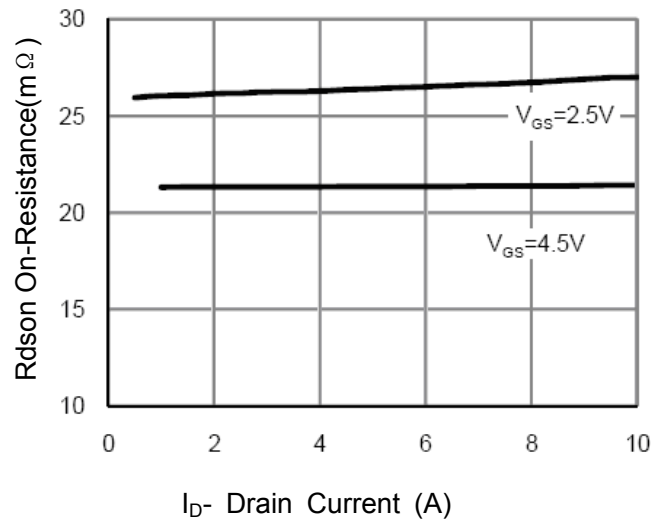

Figure 6 Drain-Source On-Resistance

AO3416

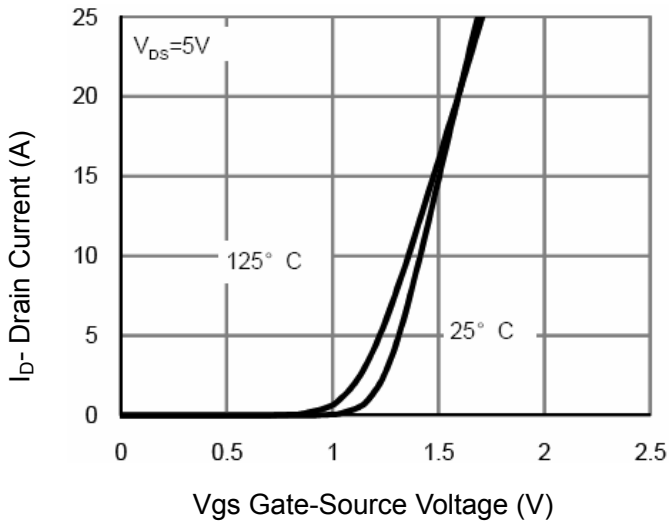

Figure 7 Transfer Characteristics

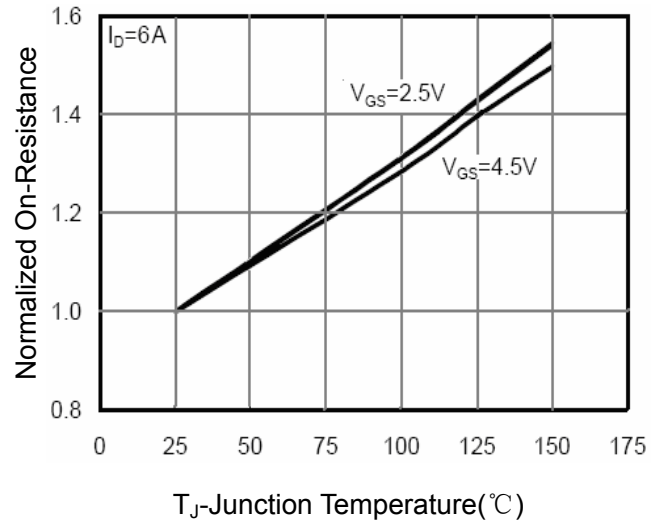

Figure 8 Drain-Source On-Resistance

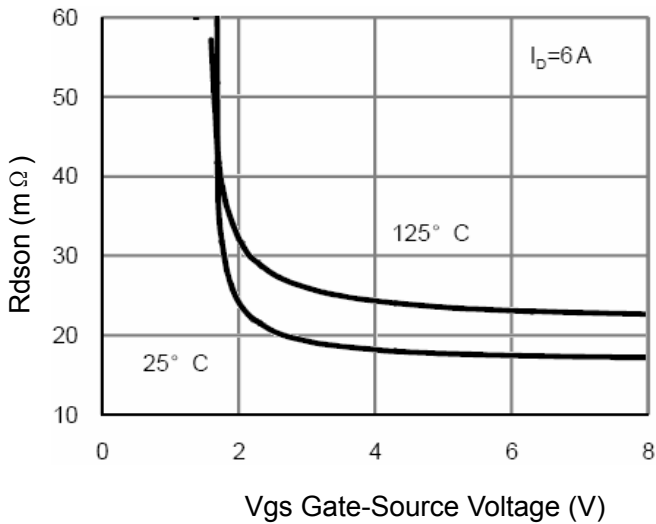

Figure 9 Rdson vs V_{GS}

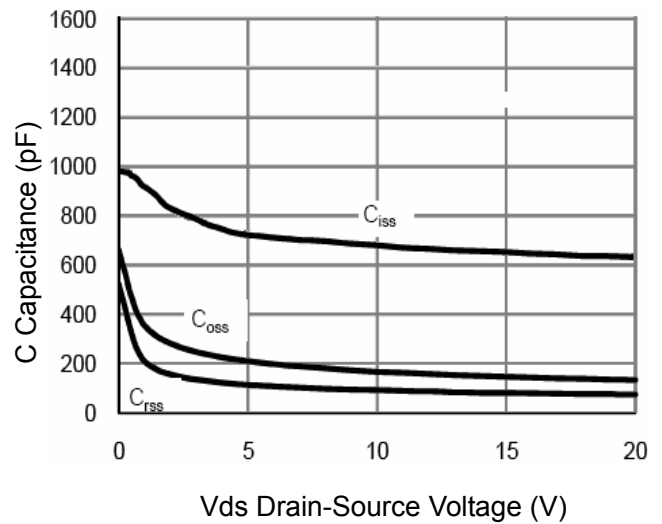

Figure 10 Capacitance vs V_{DS}

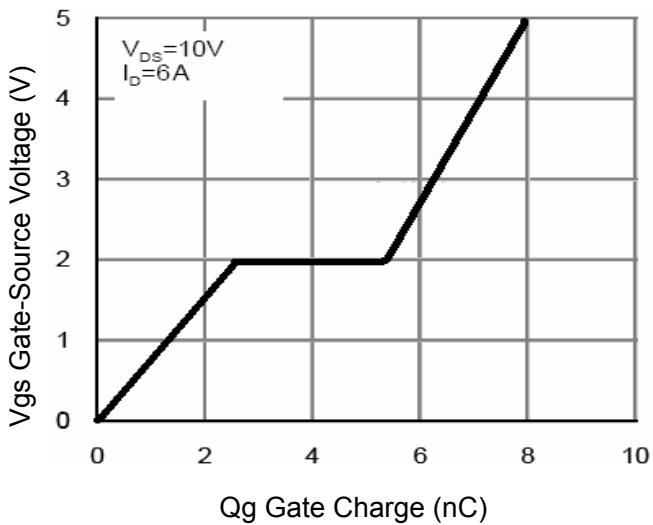

Figure 11 Gate Charge

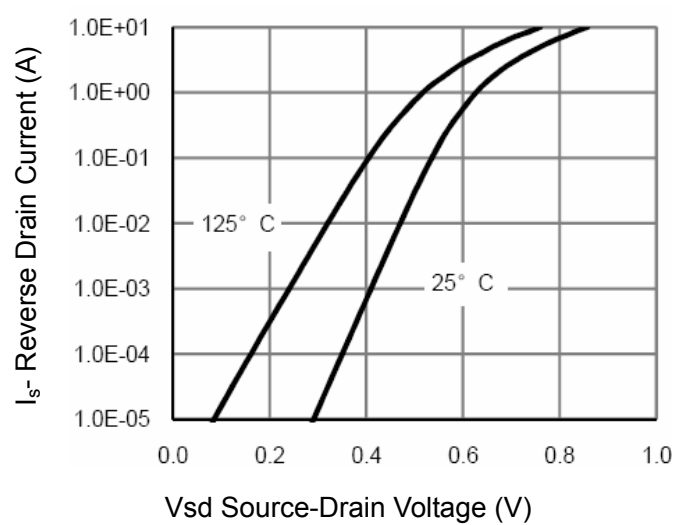

Figure 12 Source- Drain Diode Forward

AO3416

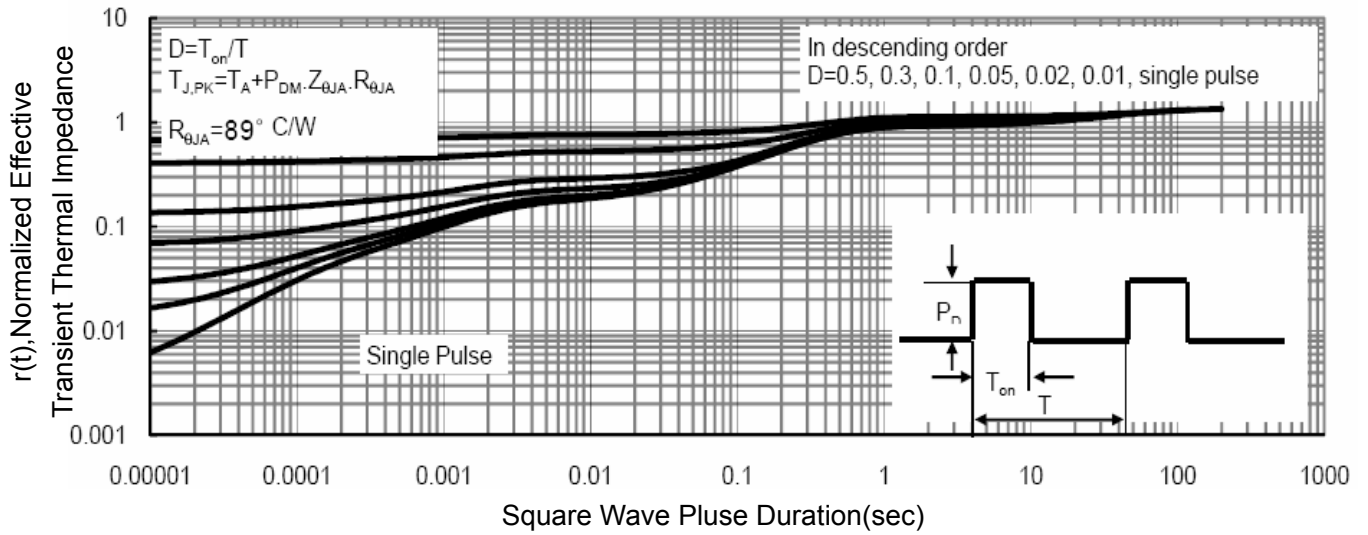
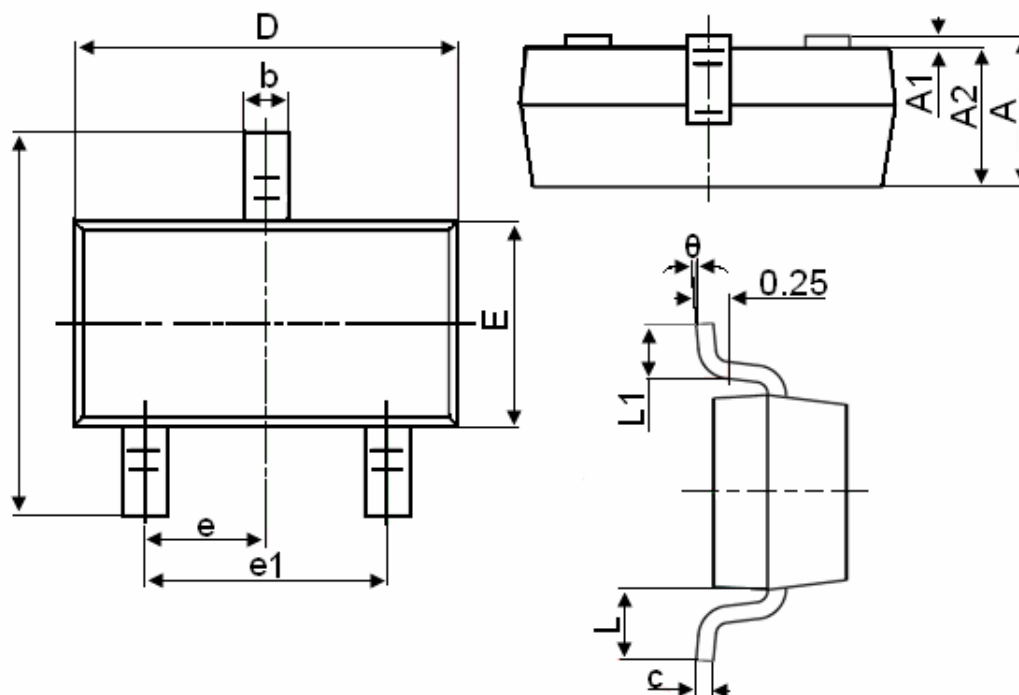

Figure 13 Normalized Maximum Transient Thermal Impedance

AO3416

SOT-23 Package Information



Symbol	Dimensions in Millimeters	
	MIN.	MAX.
A	0.900	1.150
A1	0.000	0.100
A2	0.900	1.050
b	0.300	0.500
c	0.080	0.150
D	2.800	3.000
E	1.200	1.400
E1	2.250	2.550
e	0.950TYP	
e1	1.800	2.000
L	0.550REF	
L1	0.300	0.500
θ	0°	8°

Notes

1. All dimensions are in millimeters.
2. Tolerance $\pm 0.10\text{mm}$ (4 mil) unless otherwise specified
3. Package body sizes exclude mold flash and gate burrs. Mold flash at the non-lead sides should be less than 5 mils.
4. Dimension L is measured in gauge plane.
5. Controlling dimension is millimeter, converted inch dimensions are not necessarily exact.